

Article number: 53090111

Description: KLEE Hydraulic lubricating nipple DIN 71412
H1a straight, Ø10mm push-on type

Measures

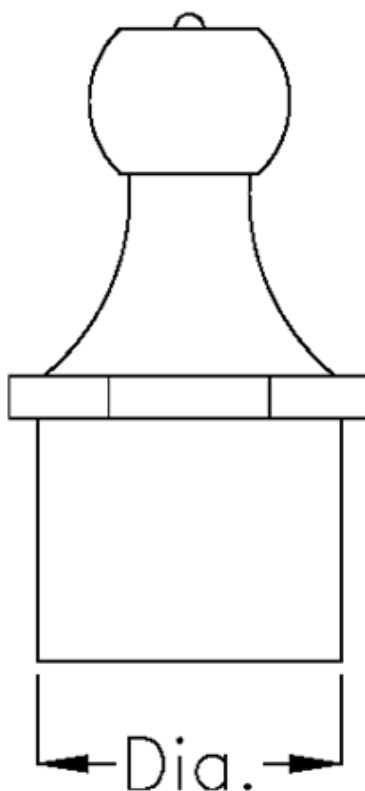

Diameter = Ø10mm